

24V/200Ah

LiFePO₄ Battery Pack
Cast aluminum version

Name: LITHIUM ION BATTERIES
Model: 24-200

Voltai

LiFePO₄ Battery Pack

Application Places

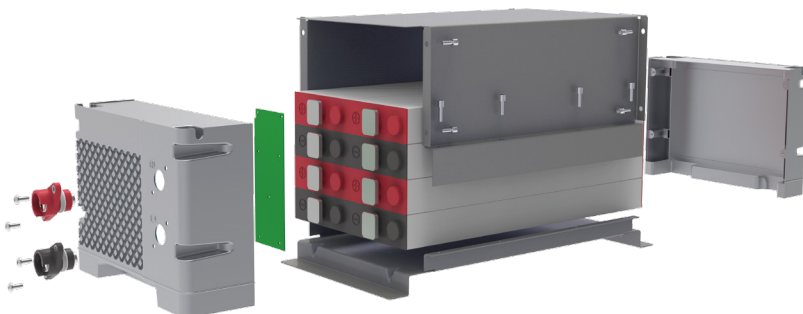

For no city power areas, the battery pack can be charged by solar panels and used for night lighting; For the areas that city power is expensive, the battery pack can be charged during the electricity valley value period, and used at the peak power period; For the areas which power off from time to time, the battery pack can be used as UPS, to avoid information loss caused by sudden power outage. The battery pack is applicable to commercial lighting, industrial lighting, home lighting, outdoor lighting, camping tourism, farming, planting, the night market stalls, etc.

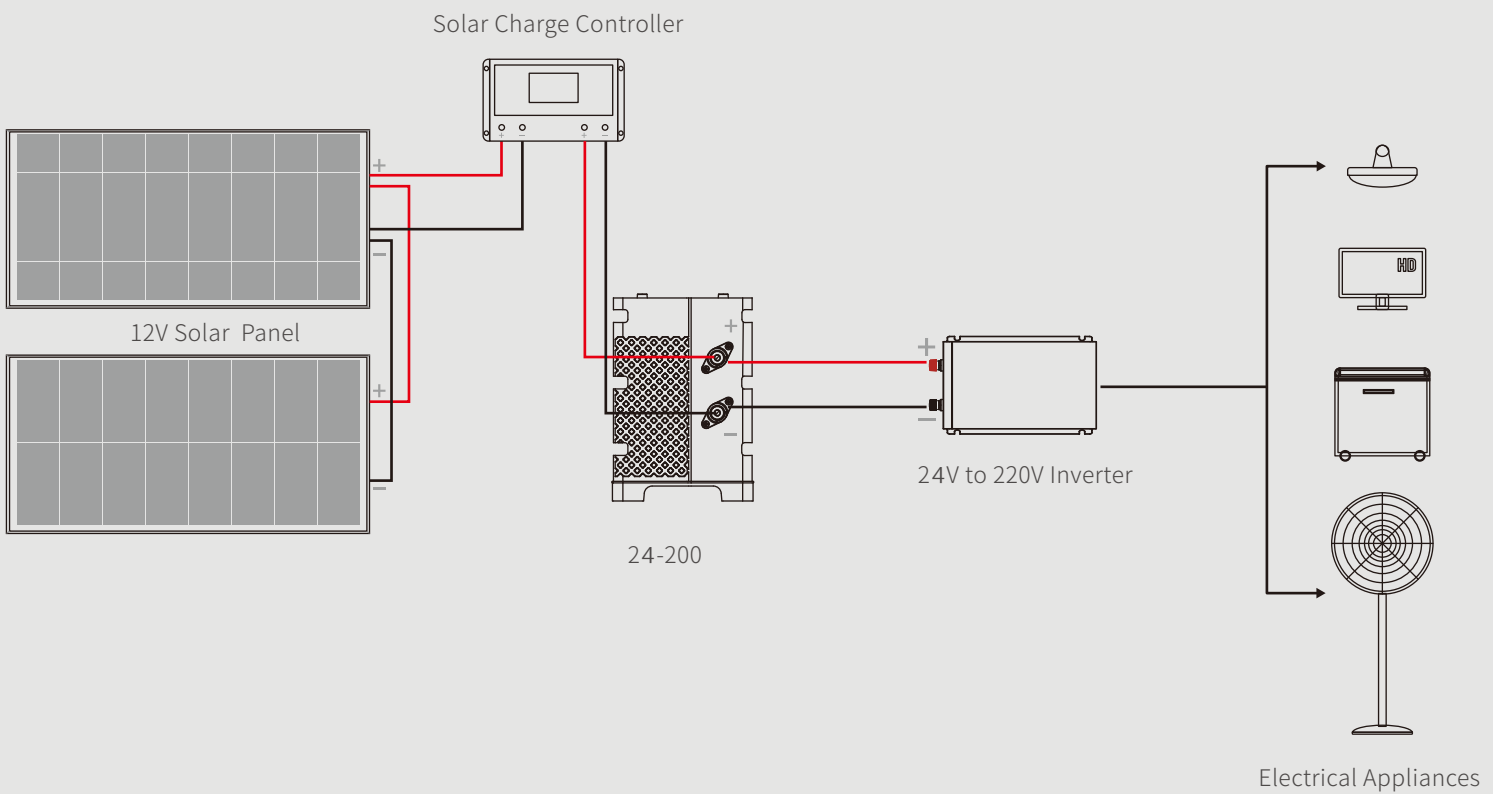
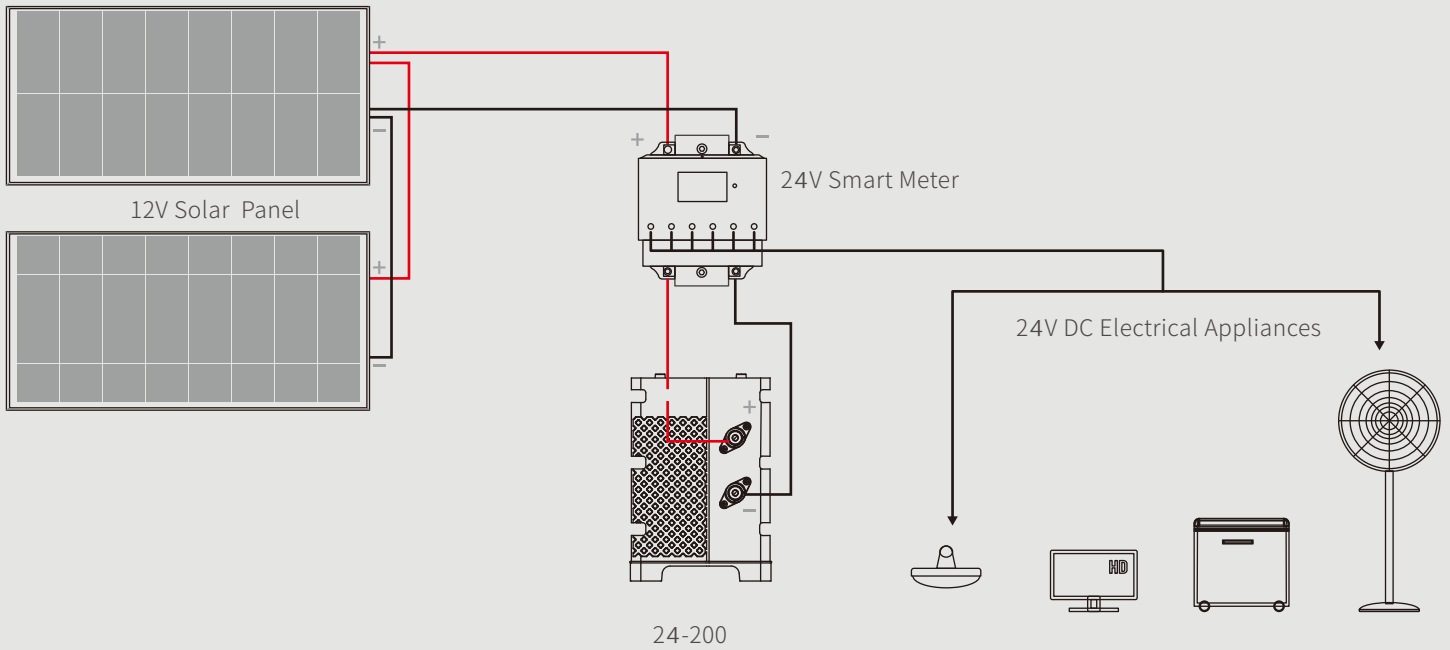

Product size : (mm)

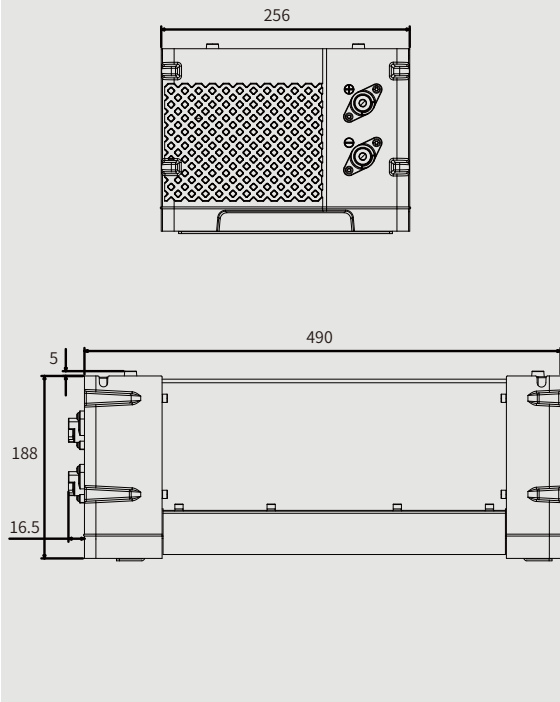

Technical Parameters

Model	24-200		
Storage capacity	5120Wh		
Standard capacity	200Ah/25.6V		
Continuously use input current	100A	Standard charging voltage	28.8V—30V
Continuously use output current	100A	Maximum charging voltage	50V
Charging voltage of solar panel	44V	Cut-off	18-24V
Charging cut-off voltage	27.6V-29.2V	Maximum solar panel input current	80A
Rshoot delay protection	1000mS	Over-discharge delay protection	1000mS
Short circuit protection recovery	Disconnect load	Short circuit protection delay	330uS
Self-Discharge (25°)	<3%/month	Depth of discharge	>80%
Cycle life	>5000 times (<0.5C)	C-rate Discharge	<0.8C
Charge method(CC/CV)	Operation: -20°C—70°C; Recommendation: 10°C—45°C		
Warranty	5 years		
Product size	507±2mm×258±2mm×193±2mm		
Package size	595±5mm×335±5mm×285±5mm/PC		

Advantages

- High quality aluminium magnesium alloy, anti-corrosion, substantial, durable, artistic, practical.
- All in one mould design and production, easy to install.
- With longer span life LiFePO₄ battery, over 12 years lifespan, ensure the whole set products' life span.
- Dustproof structure design, DC output, safe and reliable.
- Integrated packaging, safe and convenient to transport.

Voltai

Instructions

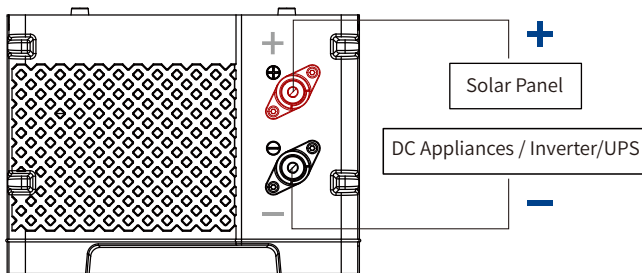

Attention:

- Please follow the guide to connect the equipments, if connecting in wrong way, the equipment have the existence of risk to be burned out.
- LiFePO₄ battery pack can be charged both by solar panels and city power.
- It is prohibited to put the battery pack outside in the rainy days.
- If charging current reached input protection current, or discharging current exceeded output protection current, the battery will stop working. This is battery protection phenomenon, will be work again when was charged(input current should be lower than input protection current).
- Maximum Support 2 battery packs in series, the highest charging voltage of 2 battery packs in series is less than 88V.
- The battery pack should not be used under overvoltage. The open circuit voltage of the 12V battery pack cannot exceed 22V; the open circuit voltage of the 24V battery pack cannot exceed 44V; the open circuit voltage of the 48V battery pack cannot exceed 88V.
- It is prohibited to repair or disassemble the battery pack by the non-professional persons.

Voltai

Battery Specification

Different Rate Discharge Curve (25°C)

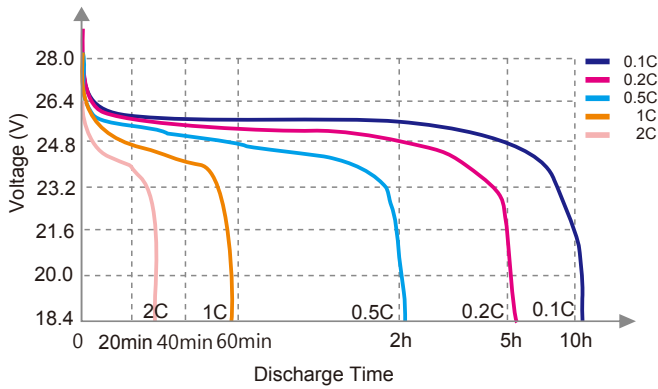

Different Temperature Discharge Curve (0.5C)

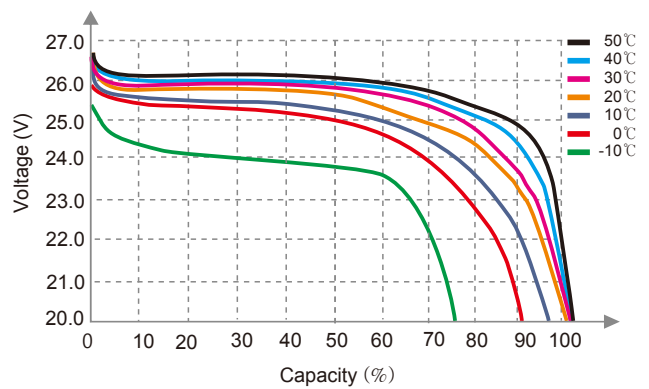

State of Charge Curve (0.5C, 25°C)

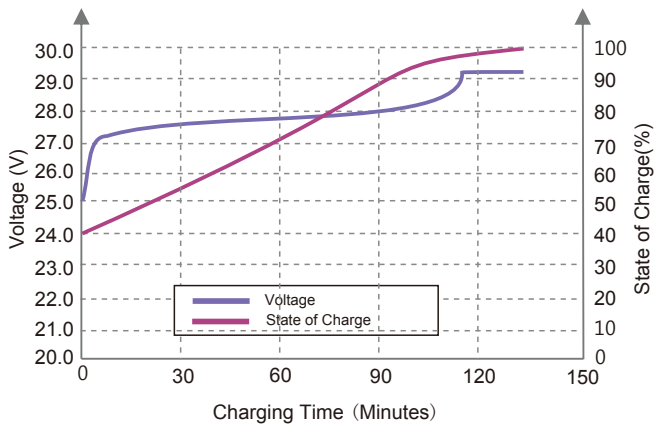

Charging Characteristics (0.5C, 25°C)

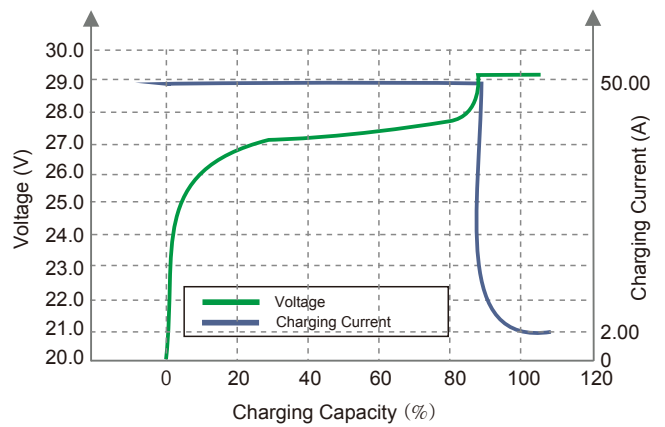

Different DOD Discharge Cycle Life Curve(1C)

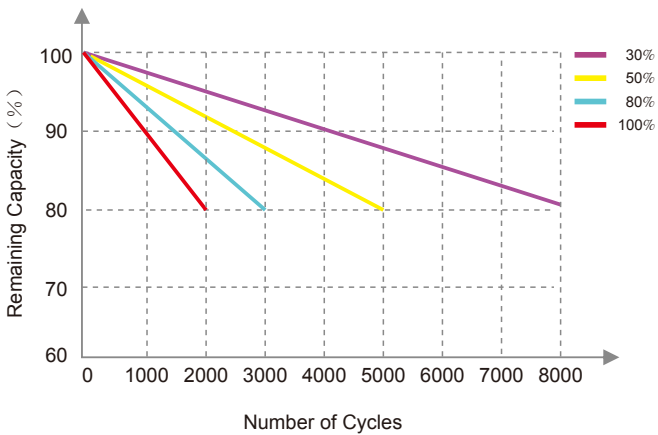

Different Temperature Self Discharge Curve

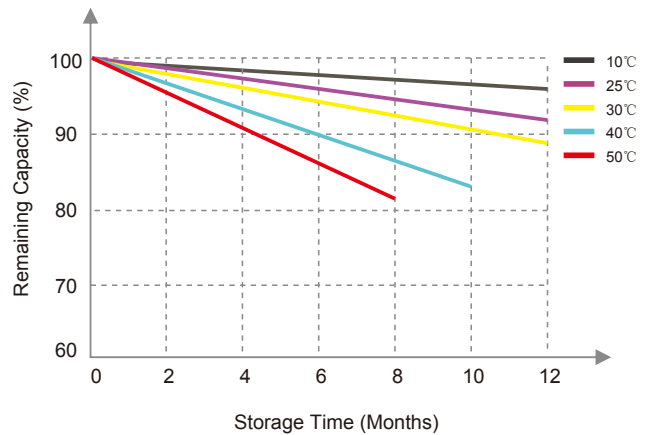



The Advantages and Characteristics of LiFePO₄ Battery

- Volume: The capacity of LiFePO₄ battery is bigger than lead-acid cell, with the same volume, it is double of Lead-acid battery.
- Weight: LiFePO₄ is light. The weight is just 1/3 of lead-acid cell with the same capacity.
- Discharge rate: LiFePO₄ battery can discharge with maximum current, it is used in electric vehicles and electric bicycles.
- No memory effect: No matter the LiFePO₄ Battery is in which conditions, it can be charged and discharged whenever you like, no need to discharge totally then charge for it.
- Durability: The durability of LiFePO₄ Battery is powerful and consumption is slow. The time of charging and discharging is more than 2000times. After 2000times circulation, the capacity of the battery is still more than 80%.
- Security: LiFePO₄ battery passed the strict safety testing, with higher safety performance.
- Environmental protection: Lithium materials not have any poisonous and harmful substance. It is regarded as green and environmental protection battery. The battery has no any pollution no matter in the process of production or in the process of using.
- Well graded and combination. After multi-selection, to ensure each cell qualified with long life;
- The connection tech of all interface, be safe and durable, with simple maintenance.
- Multi-layer protection structure, could be waterproof, shockproof, anti explosion and fire.
- Various joints, could be customized, safe and durable for long run.
- Security and reliability, compared with lead-acid battery, the materials of LiFe PO₄ is the securest, the best choice of solar energy storage battery.

Storage and Transportation

- Based on the character of cell, proper environment for transportation of LiFePO₄ battery pack need to be created to protect the battery.
- Battery should be kept at -20°C—45°C in warehouse where it's dry, clean and well-ventilated.
- During loading of battery, attention must be paid against dropping, turning over and serious stacking.



Notices

- Never use or keep the battery under the high temperature. Otherwise it will cause battery heat, get into fire or lose some function and reduce the life. The proposed temperature for long-term storage is 10-45°C.
- Never throw the battery into fire or heating machine to avoid fire, explosion and environment pollution; scrap battery should be returned to the supplier and handled by the recycle station.
- Never use the battery under strong static and strong magnetic field, otherwise it will destroy the protecting device.
- If battery leaked, the electrolyte get into eyes, please don't knead, please wash eyes by water and send to hospital. Otherwise it will hurt eyes.
- If battery emit peculiar smell, heating, distortion or appear any unconventionality during using, storage or charging process, please take it out from device or charge and stop using.
- Never cut the battery in socket directly; please use the stated charger when charging.
- Check the voltage of battery and relevant connectors before using the battery. It can't be used until everything turns out to be normal.
- Prior to charging, fully check the insulativity, physical condition and ageing status, since breakage and ageing are never allowed; the pack voltage must not be less than 10V, if not, it's abnormal and that battery needs to be labeled. The user should contact our Customer Service Dept and It can't be charged until repaired by our staff.
- The battery should be stored in half SOC. It needs to be charged once if out of use for as long as half a year.
- Clean the dirty electrode, if any, with a clean dry cloth, or poor contact or operation failure may occur.

Warning

- Never knock, throw or trample the battery.
- Never upside down the positive and negative.
- Never connect the positive and negative of battery with metal.
- Never ship or store the battery together with metal.
- Never cut through the battery with nail or other edge tool.
- Never throw the battery into water, please keep it under dry, shady and cool circumstance when not use.